



ADAM Sp. z o.o.
NOISE & VIBRATION CONTROL

Morska 9A biuro@adam.com.pl
PL 84-230 Rumia adam.com.pl
tel. / fax. +48 58 / 671 38 35

SINGLE-SPHERE
MASONFLEX MFEJ &
TWIN-SPHERE
MASONFLEX MFDEJ
SINGLE-SPHERE
SAFEFLEX SFU &
TWIN-SPHERE
SAFEFLEX SFDCR
REDUCERS

MASONFLEX NEOPRENE CONNECTORS USING SAFEFLEX CONSTRUCTION

MR NC-930-4 BULLETIN

**MASONFLEX
MFEJ
NEOPRENE
SINGLE-SPHERE
CONNECTOR**

Masonflex Neoprene connectors are all designed with multiple plies of DuPont Kevlar® tire cord and Neoprene reinforcement. They are molded in hydraulic rubber presses where high pressure air bags expand inside the preforms to force the carcasses against the mold walls.

The molds are held between heated platens, so vulcanization takes place in the press. The tube reinforcement and cover fuse with the reinforcement layers to make the construction homogenous. Thus wall sections are lighter with higher ratings in these truly flexible connectors and expansion joints.

Masonflex has been sold without interruption for approximately 25 years. In this latest improved version the Kevlar® reinforcement replaces Nylon to greatly reduce elongation and to provide virtual insensitivity to high temperatures. We have also changed the end designs to incorporate a solid steel ring under the split retention flanges. The use of a solid steel ring in place of the bead wire completely eliminates the problem of the rubber flange pulling out of the steel flange and causing major failures. These rim failures have been industry wide, and eliminating this worry more than justifies the use of Masonflex in place of competitive products.

The single sphere MFEJ is used where low cost or space limitations control. However, mechanical and acoustical performance can be almost doubled by changing to the most commonly specified twin sphere construction, MFDEJ. Twin sphere designs are more flexible and allow greater movement. The radial expansion of the twin spheres serves the purpose of smoothing out water pulsations.

SFDCR twin sphere reducers eliminate the need for cast iron or steel transition pieces usually found on both ends of pumping systems. Since the reducing fitting is eliminated, there are space, cost and labor savings.

In the smaller sizes we have found that noise problems are not so extreme. Therefore we are recommending the new Safeflex SFU threaded connector. This greatly improved product is manufactured in EPDM. The three bolt flanges make it easy for the installer to tighten the loose triangular flanges to the piping sections, insert the body with its own pair of flanges, and establish the seal by tightening three bolts.

We do not understand why pipe unions are still offered by our competitors. It is extremely difficult for a mechanic to restrain the union end screwed to the piping, the end attached to the rubber expansion joint, and to tighten the coupling nut all at the same time. It is simple to install a union when making attachment to a rigid pipe on either side, but very difficult when working with rubber connectors.

If expansion joints are installed for contraction and expansion purposes, the piping must be anchored both upstream and downstream of the connector or it will not function. Installing control rods on unanchored piping means that any manufacturer's expansion joint will always be in full open position and will never change length.

Control rods are suggested at the pressures shown in the tables only if the piping is unanchored on one or both sides and the joint is installed to control noise and vibration rather than expansion.

It is our general recommendation that flexible connectors are always installed on the equipment side of the shut-off valve, and they are not used in pipe lines that pass through finished ceilings where water damage to the structure or the equipment below can be extensive.

Other rubber materials such as Natural Rubber, EPDM, Nitrile, Hypalon, Butyl, etc. are available on special order.



FLANGE LOCK DETAIL

**MASONFLEX
MFDEJ
NEOPRENE
TWIN-SPHERE
CONNECTOR**

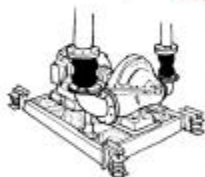

**SAFEFLEX
SFDCR
EPDM
TWIN-SPHERE
REDUCER**



**SAFEFLEX
SFU
EPDM
SINGLE-
SPHERE
UNION
CONNECTOR**



Single-Sphere MASONFLEX MFEJ

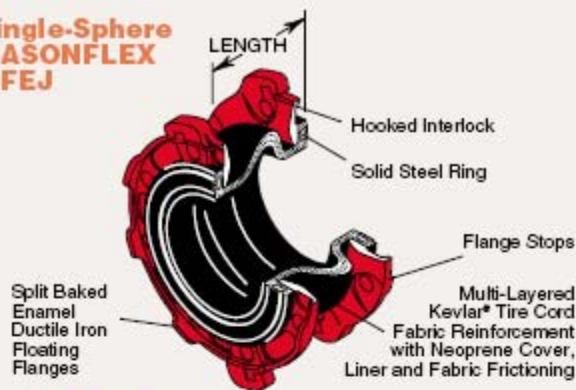

Twin-Sphere MASONFLEX MFDEJ

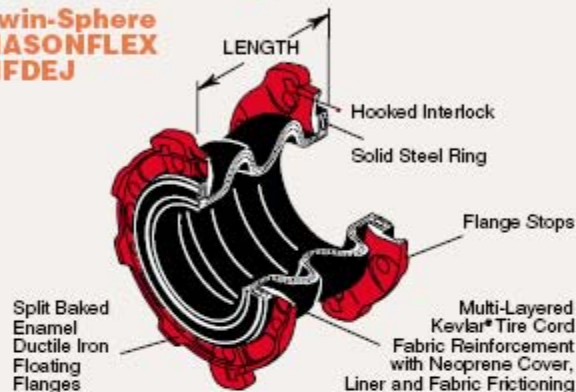

Single-Sphere SAFEXLEX SFU

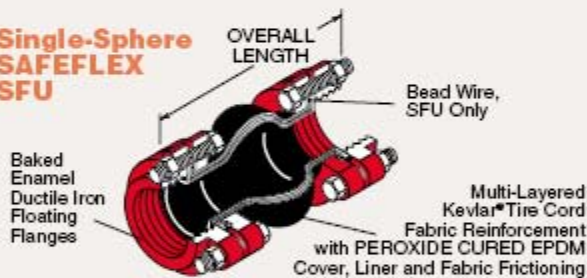

SAFEXLEX SFU-DI
Ductile Iron Threaded End

MASONFLEX MFEJ Dimensions and Allowable Movements

Pipe (in)		Pipe (mm)		Allowable Movements			
Size (in)	Length (in)	Size (mm)	Length (mm)	Angular (degrees)	Compression (in) (mm)	Elongation (in) (mm)	Transverse ±(in) (mm)
2	4	50	100	20°	5/8 16	1/2 12	3/8 9.5
2 1/2		65		19°			
3	6	75	150	18°	7/8 22	5/8 16	5/8 16
4		100		17°			
5		125		16°			
6		150		15°			
8	200	13°					
10	8	250	200	12°	1 25	3/4 19	3/4 19
12		300		11°			
14	9	350	225	10°	1 1/8 29	7/8 22	7/8 22
16		400		9°			
18		450		8°			
20		500		7°			
24	10	600	250	6°	1 1/8 29	1 25	1 25

MASONFLEX MFDEJ Dimensions and Allowable Movements

Pipe (in)		Pipe (mm)		Allowable Movements			
Size (in)	Length (in)	Size (mm)	Length (mm)	Angular (degrees)	Compression (in) (mm)	Elongation (in) (mm)	Transverse ±(in) (mm)
1 1/2	6	40	150	30°	7/8 22	5/8 16	5/8 16
2		50		28°			
2 1/2		65		27°			
3	9	75	225	26°	1 1/8 29	7/8 22	7/8 22
4		100		25°			
5		125		24°			
6		150		23°			
8	200	22°					
10	12	250	300	21°	1 1/2 38	1 25	1 1/4 32
12		300		20°			

SAFEXLEX SFU Dimensions and Allowable Movements

Pipe (in)		Pipe (mm)		Allowable Movements			
Size (in)	Length (in)	Size (mm)	Length (mm)	Angular (degrees)	Compression (in) (mm)	Elongation (in) (mm)	Transverse ±(in) (mm)
3/4	7	20	175	25	3/4 19	3/8 10	3/8 10
1		25		24			
1 1/4	8	32	200	23			
1 1/2		40		22			
2	8	50	200	21			

SFU FITTING OPTIONS



SAFEXLEX SFU-SS
Stainless Steel Threaded End



SAFEXLEX SFU-CT
Sweat End for Copper Tubing



SAFEXLEX SFU-PC
PVC Cement End



SAFEXLEX SFU-PT
PVC Threaded End



SAFEXLEX SFU-BT
Brass Threaded End

MASONFLEX MFEJ, MFDEJ, SAFEXLEX SFU and SFDCR with Kevlar® Reinforcement Standard and High Pressure Construction Temperature Corrections

Construction Types & Sizes (in) (mm)	Nominal Rating in PSI at: Operating Temperatures (°F)						Max Vacuum (in Hg)	Nominal Rating in Bar at: Operating Temperatures (°C)						Max Vacuum (-Bar)
	170°	180°	190°	200°	210°	220°		77°	82°	88°	92°	99°	102°	
MFEJ Standard 2"-16" 50mm-400mm	225	220	215	210	205	200	18"	15.5	15.2	14.8	14.5	14.1	13.8	0.6
MFEJ Standard 18"-24" 450mm-600mm	180	180	175	170	165	160	18"	12.4	12.4	12.1	11.7	11.4	11.0	0.6
MFDEJ Standard All Sizes	225	220	215	210	205	200	10"	15.5	15.2	14.8	14.5	14.1	13.8	0.3
SFDCR Standard All Sizes	250	245	240	235	230	230	14"	17.2	16.9	16.5	16.2	15.8	15.8	0.5
SFU Standard All Sizes	250	245	240	235	230	230	18"	17.0	16.5	16.5	16.2	15.8	15.8	0.6
MFEJ High Pressure 2"-16" 50mm-400mm	300	290	280	270	260	250	29"	20.7	20.0	19.3	18.6	18.0	17.2	1.0
MFEJ High Pressure 18"-24" 450mm-600mm	225	220	215	210	205	200	29"	15.5	15.2	14.8	14.5	14.1	13.8	1.0

Burst pressures are a minimum of three times Operating Pressures.

High Pressure 14" - 24" 450 - 600mm MFEJ are special order. All other models are stock.

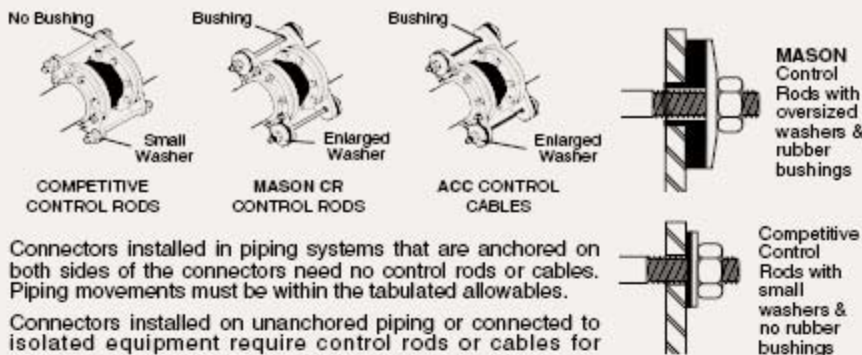

Connectors installed in piping systems that are anchored on both sides of the connectors need no control rods or cables. Piping movements must be within the tabulated allowances.

Connectors installed on unanchored piping or connected to isolated equipment require control rods or cables for pressures as tabulated.

Type CR and ACC control rods and cables are very different than the average rod and rubber washer arrangement. Our sets are all made with oversized washers on the ends to limit the maximum loading on the rubber materials to 1000psi (70kg/cm²). Competitive systems use 1/4" (6mm) rubber washers that are the same size as the small standard washers. Thrust forces are so high that standard washers extrude out. In addition to the increased area and thickness of the rubber materials, all our control rod washers are molded with rubber bushings so the rod or cable cannot contact the steel restraining plates and short circuit the system acoustically.

Installation Instructions for Masonflex MFEJ & MFDEJ

Install only where leakage will not result in injury or property damage.

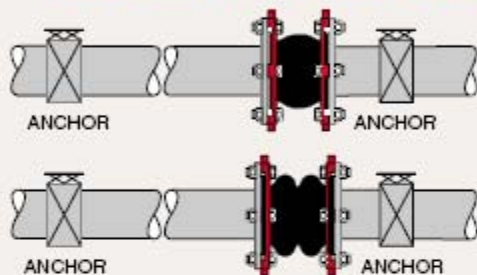

MFEJ AND MFDEJ CONNECTORS THAT ARE USED IN EXPANSION APPLICATIONS MUST BE INSTALLED WITH ANCHORS ON EITHER SIDE OF THE CONNECTOR.

MFEJ AND MFDEJ CONNECTORS USED AS NOISE AND VIBRATION DAMPENERS ONLY AND INSTALLED IN UNANCHORED PIPING WILL GROW IN RESPONSE TO THE PRESSURE AS SHOWN BELOW. Adjust the spring mountings so the equipment is at the proper level. Leave a space between pipe flanges equal to the length shown below and draw the connectors out evenly with the flange bolts. Spring supported equipment may lift in response to the tightening so the connector may not be fully extended. When the connector is at operating pressure the system will return to the original position.

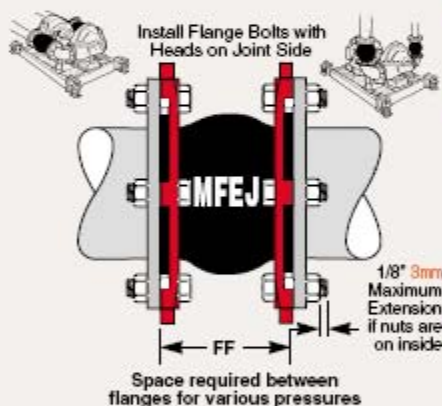

MASONFLEX MFEJ Pressure Extension Table

Pipe Size (in)	225psi Construction						Pipe Size (mm)	15.3 Bar Construction					
	0 psi	50 psi	100 psi	150 psi	200 psi	225 psi		0 Bar	3.4 Bar	6.8 Bar	10.2 Bar	13.6 Bar	15.3 Bar
	Face to Face Length (in)							Face to Face Length (mm)					
2	4	4	4	4	4	4	50	100	100	100	100	100	100
2 1/2	4	4	4	4	4	4	65	100	100	100	100	100	100
3	6	6	6	6	6	6	75	150	150	150	150	150	150
4	6	6	6	6	6	6 1/16	100	150	150	150	150	150	151
5	6	6	6	6	6	6 1/16	100	150	150	150	150	151	153
6	6	6	6	6 1/16	6 1/16	6 1/8	150	150	150	150	151	153	155
8	6	6	6 1/16	6 1/8	6 3/16	6 1/4	200	150	150	151	153	155	156
10	8	8	8 1/16	8 1/8	8 3/16	8 1/4	250	200	200	201	203	205	206
12	8	8	8 1/16	8 1/8	8 1/4	8 3/8	300	200	200	201	203	206	210
14	9	9	9 1/8	9 1/4	9 3/8	9 1/2	350	225	225	228	231	235	238
16	9	9 1/8	9 1/4	9 3/8	9 1/2	9 5/8	400	225	228	231	235	238	241
	180psi Construction							12.3 Bar Construction					
Pipe Size (in)	0 psi	50 psi	100 psi	150 psi	180 psi		Pipe Size (mm)	0 Bar	3.4 Bar	6.8 Bar	10.2 Bar	13.6 Bar	
	Face to Face Length (in)							Face to Face Length (mm)					
18	9	9 1/4	9 3/8	9 1/2	9 5/8	450	225	231	235	238	241		
20	9	9 1/4	9 3/8	9 1/2	9 5/8	500	225	231	235	238	241		
24	10	10 1/4	10 1/2	10 5/8	10 3/4	600	250	256	262	266	269		

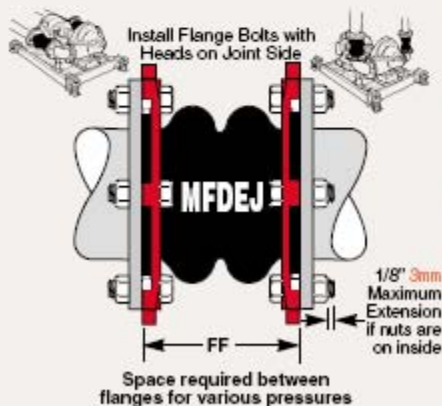

MASONFLEX MFDEJ Pressure Extension Table

Pipe Size (in)	225psi Construction						Pipe Size (mm)	15.3 Bar Construction					
	0 psi	50 psi	100 psi	150 psi	200 psi	225 psi		0 Bar	3.4 Bar	6.8 Bar	10.2 Bar	13.6 Bar	15.3 Bar
	Face to Face Length (in)							Face to Face Length (mm)					
1 1/2	6	6	6	6	6	6	40	150	150	150	150	150	150
2	6	6	6	6	6	6	50	150	150	150	150	150	150
2 1/2	6	6	6	6	6 1/16	6 1/8	65	150	150	150	150	151	153
3	9	9	9	9	9 1/16	9 1/8	75	225	225	225	225	226	228
4	9	9	9 1/16	9 1/8	9 3/16	9 1/4	100	225	225	226	228	230	231
5	9	9 1/16	9 1/8	9 3/16	9 5/16	9 3/8	125	225	226	228	230	233	235
6	9	9	9 1/8	9 1/4	9 3/8	9 1/2	150	225	225	228	231	235	237
8	9	9 1/8	9 1/4	9 3/8	9 1/2	9 5/8	200	225	228	231	235	237	241
10	12	12 3/16	12 3/8	12 9/16	12 3/4	12 7/8	250	300	305	310	313	319	322
12	12	12 3/16	12 3/8	12 9/16	12 3/4	12 7/8	300	300	305	310	313	319	322

CAUTION: This extension procedure is an **ABSOLUTE** must on all connections to spring mounted systems such as pumps (when control rods are not used) or the connectors may drive the spring solid under the pumps or shift the foundation.

All high pressure connectors should have control rods set at maximum expansion joint elongation.

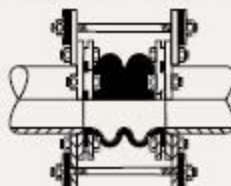

Use Control Rods or Cables only if:

1. Expansion Joints cannot be preextended.
2. Pipe movement is no problem.
3. As an added precaution.

SAFEX SDCR

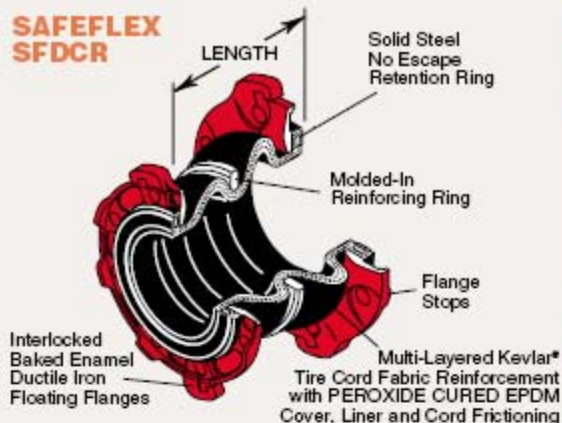

All flanged expansion joints illustrated in this bulletin are available with:

- 150 lb ASA Drilling
- 300 lb ASA Drilling
- BRITISH Series E Drilling
- BRITISH Series F Drilling
- DIN or PIN-10
- DIN or PIN-16
- DIN or PIN-25

SAFEX SDCR Dimensions and Allowable Movements

Pipe (in)		Pipe (mm)		Allowable Movements						
Size (in)	Length (in)	Size (mm)	Length (mm)	Angular (degrees)	Compression (in)	Elongation (in)	Transverse ±(in)	(mm)	(mm)	
3x2	6	75x50	150	25°	1	25	5/8	16	5/8	16
3x2 1/2	6	75x85	150							
4x3	7	100x75	175	20°	1 1/4	32	3/4	19	3/4	19
5x4	8	125x100	200							
6x4	9	150x100	200	15°	1 5/8	41	3/4	19	7/8	22
6x5	9	150x125	225							
8x6	11	200x150	275							
10x8	12	250x200	300							

SAFEX SDCR Pressure Extension Table

Pipe Size (in)	250psi Construction				Pipe Size (mm)	17 Bar Construction			
	0 psi	100 psi	200 psi	250 psi		0 Bar	6.8 Bar	13.6 Bar	17 Bar
	Face to Face Length (in)					Face to Face Length (mm)			
3x2	6	6 1/8	6 3/16	6 1/4	75x50	150	153	155	156
3x2 1/2	6	6 1/8	6 3/16	6 1/4	75x85	150	153	155	156
4x3	7	7 1/8	7 1/4	7 3/8	100x75	175	178	181	185
5x4	8	8 3/16	8 3/8	8 1/2	125x100	200	205	210	212
6x4	9	9 3/16	9 3/8	9 1/2	150x100	225	230	235	237
6x5	9	9 1/4	9 7/16	9 9/16	150x125	225	231	236	239
8x6	11	11 3/8	11 1/2	11 5/8	200x150	275	285	287	291
10x8	12	12 1/2	12 3/4	13	250x200	300	312	319	325

Installation Procedures for Masonflex MFEJ, MFDEJ, Safeflex SDCR and SFU

It is our general recommendation that flexible connectors are always installed on the equipment side of the shut-off valve, and they are not used in pipe lines that pass through finished ceilings where water damage to the structure or the equipment below can be extensive.

Install only where leakage or failure will not result in injury or property damage.

- Expansion joint rubber flanges must be in contact with a flat surface. Normal 1/16" raised face is o.k. Unacceptable depressions or protrusions are typical of vicialuc or similar flanges.
 - Flange stops must bear on full diameter mating flanges.
 - Rubber flanges will not retain loose elements in valve bodies that rely on contact with a steel flange. For example, some check valves are manufactured with brass inserts positioned by screws. When mating steel flanges with these valves, there is no problem. However, with a rubber connector, it cuts the rubber face and can cause failure, leakage or brass insert escape.
- Any of the above conditions must be corrected by installing a minimum 1/2" thick full diameter steel flange drilled to standard dimensions so the flange bolts pass through it. The I.D. matches the O.D. of the piping. Gasket between this filler flange and the mating steel flange.
- Before installing the connector be certain that all surfaces are clean and there are no sharp edges of any kind on the steel flanges. No gasket is required. Apply a thin film of graphite dispersed in glycerin or water to the face of the rubber flanges before installing. No other type of lubricant or seal should be used on the flange face. The graphite prevents the rubber from adhering to the metal flange so that the rubber joint can be removed without damage, should it ever be necessary.
- If the connector is to be installed in a system where the operating pressures do not dictate the use of control rods, but the connector is to be pre-extended to allow for growth under pressure, the gap between the piping flanges should be large enough to allow for the growth as indicated on the operating pressure chart.
- Expansion joints installed for expansion and compression applications should be installed at normal length. Check allowable movements against design requirements between anchors.
- Check temperature and pressure ratings and never exceed them.
- Check for chemical compatibility with the ordered material.
- Do not weld near the expansion joints or weld the steel flanges to the piping after the expansion joints are installed. This will either burn or seriously damage the expansion joints.

- Although the expansion joints will readily adjust themselves to misaligned flanges within the specified movements, they should not be installed where there is more than 1/8" of initial misalignment or lack of parallelism in the expansion joints.
- Slide the connector into position and insert all the flange bolts. The rubber face must be centered exactly on the opening. Be sure that the bolts are inserted with the heads facing the rubber and the nuts on the outside so they are on the outside of the mating flange. If it is impossible to insert the bolts in this direction, the tightened end of the bolt must not protrude more than 1/8" beyond the inside nut. Larger protrusions may result in the bolt cutting into the rubber cover.
- After all bolts are inserted, make them finger tight and then proceed to adjust them evenly in a circle. Tighten the bolts to 60% of the maximum recommended torque for the bolt size until all bolts have the same tightness. Tightness may be increased if there is joint leakage.
- All rubber materials tend to relax over a period of time. It is good practice to check the tightness of the bolts for the 60% torque about two weeks after installation, and in extreme cases, particularly when a line is heated up and allowed to cool repeatedly, it is advisable to continue to check bolt tightness on a monthly basis until such time as the last check shows no further tightening is required.
- Allowing the bolts to loosen may cause leaks.
- Insulation on cold lines should be installed for easy removal to facilitate retightening.
- In order to prevent heat buildup, expansion joints in hot lines should not be insulated.
- While all our expansion joints are guaranteed for a period of one year and designed for many years of service, it is suggested that expansion joints are replaced every five years. Cover cracking is of no significance and only cosmetic.

SFU Installation Instructions (See general precautions above)

- Attach flanges to piping so length between inside flange faces is equal to face to face length of rubber section of the SFU.
- Insert center section of the SFU and the 3 bolts on each end. Tighten evenly to 60% of torque value.
- Retighten as in 12 above.

IT IS IMPORTANT TO FOLLOW ALL OF THE NUMBERED INSTRUCTIONS TO AVOID NEEDLESS PROBLEMS.



ADAM Sp. z o.o.
NOISE & VIBRATION CONTROL

Morska 9A
PL 84-230 Rumia
tel. / fax +48 58 671 38 35

biuro@adam.com.pl
adam.com.pl